



# P40 Agile P14N, P14D, P94V

## P40 Agile Feeder Management

The P14N non-directional feeder, P14D directional feeder and P94V voltage and frequency IEDs bring the design rigour and technology of transmission applications to the entire utility and industrial market.

The footprints of both the device physical size and the lifecycle environmental impact have been minimised using state-of-the-art design, component, and process selection. Agile solutions from GE are ideal for new-build and retrofit alike.

### Agility and Versatility

MIKOM P40 Agile IEDs provide an integrated solution for the complete protection, control and monitoring of electrical power systems. Application for overhead lines, underground cables, busbars, breakers, transformers, reactors and distributed generation is supported, right from distribution (as primary protection) to transmission voltage levels (as back-up). The IEDs are suitable for a wide variety of applications in solidly-earthed, resistance-earthed and Petersen coil systems alike.

### The Perfect Balance: standardised and adaptable

MODEL	HARDWARE BASE	INTENDED APPLICATION	CASE MODEL
P14NB	P14N	Non-directional feeder	20, 30 or 40TE
P14NZ <sup>(1)</sup>	P14N	Non-directional feeder with HIF <sup>(2)</sup>	20, 30 or 40TE
P14DA	P14D	Directional feeder adapted to 20TE case	20TE
P14DB	P14D	Directional feeder	20, 30 or 40TE
P14DH	P14D	Directional feeder with Wattmetric Directional earth fault	30TE or 40TE
P14DG	P14D	Distributed generation	30TE or 40TE
P14DL	P14D	Advanced directional feeder protection (with autoreclose and fault locator)	30TE or 40TE
P14DZ <sup>(1)</sup>	P14D	Advanced directional feeder with with HIF or TEFD <sup>(3)</sup>	30TE or 40TE
P94VB	P94V	Voltage and frequency	20, 30 or 40TE
P94VP	P94V	Voltage and frequency with check synchronising	20, 30 or 40TE
P94VR	P94V	Voltage ad frequency with autoreclose and check synchronising	20, 30 or 40TE

(1) Only with sensitive earth fault CT option - (2) HIF: High Impedance Fault (downed conductor) - (3) TEFD: Transient Earth Fault Detection

## Protection and Control

- Comprehensive current, voltage, power and frequency protection functions
- Multi-stage independent protection elements, variety of curves in 4 setting groups
- High Impedance Fault, Load Encroachment, Switch onto fault and Fault Locator
- Rate of change, full-scheme auto-reclose, TEFD and synchrocheck

## Metering and Monitoring

- Comprehensive metering & power-up diagnostics
- Two stage circuit breaker failure and breaker condition monitoring
- Switchgear supervision including CT/VT, DC supply, full Trip Circuit Supervision, CB failure
- Switch control and status (up to 8) and up to 2048 events and 10.5 s disturbance records

## Advanced Communications

- Up to two Ethernet ports with options for redundancy protocols (RSTP or PRP/HSR)
- SNTP or IRIG-B time synchronization
- Multiple communication protocols including IEC 61850, Modbus, DNP 3.0, IEC 60870-5-103 and Courier/K-Bus

## Ease-of-Use

- Compact and withdrawable design with 4", 6" and 8" size options
- Simplified standardization via programmable binary input voltage, universal CTs and power supply
- Seamless migration of K-Series relays
- Easy field relay upgrade



## Functional Overview

ANSI code	Function	P14NB	P14NZ	P14DA	P14DB	P14DH	P14DG	P14DL	P14DZ	P94VB	P94VP	P94VR
		Non-Directional				Directional				Voltage & Frequency		
50	Definite time overcurrent	6	6	6	6	6	6	6	6			
50N	Neutral/Earth definite time overcurrent	4	4	4	4	4	4	4	4			
51	IDMT overcurrent	3	3	3	3	3	3	3	3			
51N	Neutral/Earth IDMT overcurrent	2	2	2	2	2	2	2	2			
50/51SEF	Sensitive earth fault	4	4	4	4		4	4	4			
51V	Voltage controlled overcurrent			*	*	*	*	*	*			
	Voltage restrained overcurrent						*	*	*			
50 SOTF	Switch on to fault	*	*	*	*	*	*	*	*			
68	Inrush blocking	*	*	*	*	*	*	*	*			
	Cold load pick up	*	*	*	*	*	*	*	*			
	Load encroachment supervision (Load blinders)							*	*			
HIF	High impedance Earth fault		*									*
TEFD	Transient Earth Fault Detection											*
46	Negative sequence overcurrent	4	4	4	4	4	4	4	4			
46BC	Broken conductor	*	*	*	*	*	*	*	*			*
	Programmable curves	4	4	4	4	4	4	4	4			
67	Directional phase overcurrent			6	6	6	6	6	6			
67N	Directional neutral overcurrent			4	4	4	4	4	4			
	Sensitive directional earth fault			4	4		4	4	4			
	Wattmetric earth fault			*	*	*	*	*	*			*
	Wattmetric directional earth fault					2						
	Blocking scheme	*	*	*	*	*	*	*	*			*
37	Undercurrent detection (low load)	*	*	*	*	*	*	*	*			*
32	Phase directional power (Forward / Reverse / Under / Over)					2	2	2	2			
49	Thermal overload	*	*	*	*	*	*	*	*			*
50BF	CB failure	2	2	2	2	2	2	2	2			
21FL	Fault locator									*	*	
	Neutral admittance							*	*			
27/59	Undervoltage / Overvoltage			3	3	3	3	3	3	3	3	3
27V <sub>i</sub> /59V <sub>i</sub>	Positive sequence undervoltage/ overvoltage			2	2	2	2	2	2	2	2	2
59N	Residual overvoltage (Measured or derived)			3	3	3	3	3	3	3	3	3
47	Negative sequence overvoltage			2	2	2	2	2	2	2	2	2
dv/dt	Rate of change of voltage							4	4		4	4
79	Autoreclose (number of shots)		4					4	4			4
25	Check synchronising; Synchrocheck: (NA with open delta 4th VT input)						*	*	*		*	*
	Voltage Vector Shift ( $\Delta V\theta$ )						*	*	*			
81O	Overfrequency				9	9	9	9	9	9	9	9
81U	Underfrequency				9	9	9	9	9	9	9	9
81V	Undervoltage blocking of frequency protection			*	*	*	*	*	*	*	*	*
81df/dt	Rate of change of frequency				9	9	9	9	9	9	9	9
81Rf	Frequency supervised - rate of change of frequency							9	9		9	9
81RAV	and average rate of change of frequency							9	9		9	9
81R	Frequency restoration							9	9		9	9
64N	Restricted earth fault	*		*	*	*	*	*	*			*
87B	High impedance busbar (with external stabilizing & non-linear resistors)	*		*	*							*
PSL	Programmable scheme logic	*	*	*	*	*	*	*	*	*	*	*
86	Latching output contacts (Lockout)	*	*	*	*	*	*	*	*	*	*	*
	Switch Status and Control	*	*	*	*	*	*	*	*	*	*	*
VTS	VT supervision			*	*	*	*	*	*			*
CTS	CT supervision			*	*	*	*	*	*			*
	DC supply supervision	*	*	*	*	*	*	*	*	*	*	*
	CB condition monitoring	*	*	*	*	*	*	*	*	*	*	*
	Setting groups	4	4	4	4	4	4	4	4	4	4	4

## Intuitive User Interfaces

The front-panel interface (shown in Figure 1) allows direct IED interaction. A USB front port offers enhanced access by laptop computers. Integrated user function keys and tri-colour programmable LEDs provide a cost-effective solution for control and annunciation. Numerous, optional, modern communication protocols, including IEC 61850, ensure interfacing to upper-level Supervisory, Control, Automation or Data Acquisition systems.

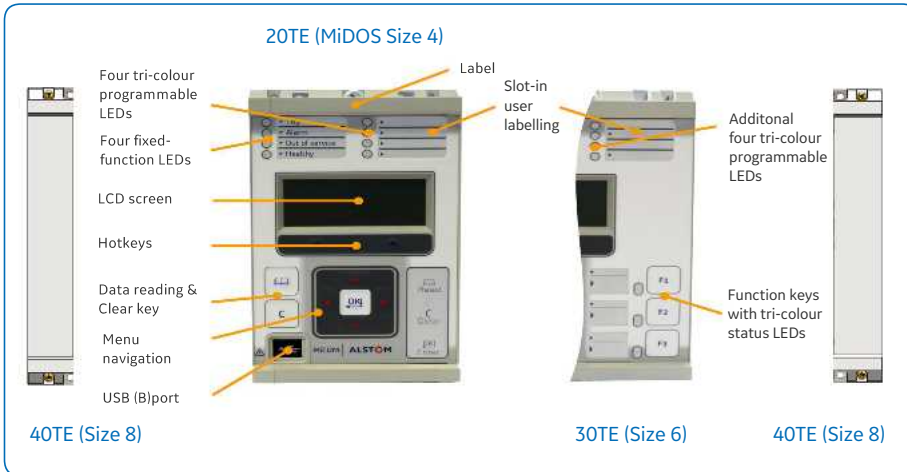

P40 Agile front panel interface

## Environmental Responsibility

The IEDs are manufactured in a lead-free soldering process using lead-free components. Power dissipation is the lowest among comparable products, easing concern on station batteries. Even the product weight (including packaging) has been optimised to lessen the transit carbon footprint. All such actions boost the eco-responsibility demonstrated in the Product Environment Profile (PEP). The product does not require any resident battery.

The PEP shows claims for raw material depletion, energy depletion, water depletion, global warming potential, ozone depletion, photochemical ozone creation, air acidification, and hazardous waste production.

## Quality Built-in

Quality Built-In methodology is applied throughout the development and manufacturing of the IEDs. Parts stress analysis in R&D, rigorous component supplier selection, and a shipping carton compliant with ISTA protection requirements all are examples of best-practice to maximise long-life reliability. All circuit boards have harsh environmental coating, to resist moisture, salt, corrosive atmosphere and industrial ambient pollution – as standard. Circuit board production uses in-circuit tests, boundary scanning, built-in self-test, automated optical inspection, and X-ray scanning to achieve maximum test coverage.

Figure 2 depicts the software scalability of models, within the overall superset of the range functionality. The strong P40 family identity offers high customer familiarity, with minimal training requirements.

## Cyber-Security

The sophistication of protection schemes, coupled with the advancement of technology, increasingly leads to devices and substations being interconnected with open networks, such as the internet or corporate-wide networks. This introduces a potential security risk making the grid vulnerable to cyber-attack, which could in turn lead to electrical outage. To secure communication within such environments, MiCOM P14N, P14D and P94V offer NERC-compliant cyber security.

## Asset Life Extension

In addition to new-build, P40 Agile IEDs can be used to refurbish legacy protection schemes. As MiCOM P14N and P14D are pin-to-pin compatible with KCGG14x and KCEG14x respectively, they can simply be plugged-in to the K relay cases for an easy upgrade. Draw-out substitute strategy along with setting conversion tool dramatically reduce the refurbishment time and cost.

## Hardware

All models offer:

- Space-saving 4U height and 20TE (4"), 30TE (6") or 40TE (8") case sizes
- A front USB port and a rear RS485 port
- Power-up diagnostics and continuous self-monitoring
- Wide choice of opto-isolated binary inputs and output relays
- N/O (form A) and N/C (form B) watchdog contacts
- Field upgradeable to change the relay model avoiding costly hardware change via firmware upgrade

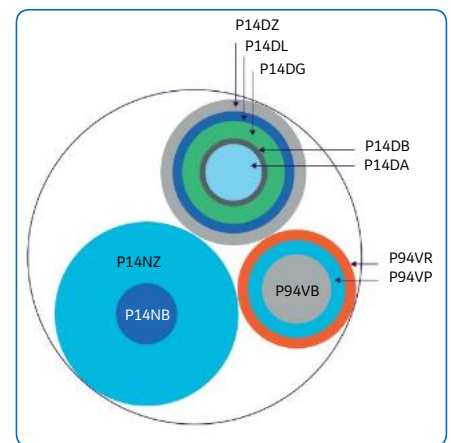

P40 Agile application scalability

## Hardware Overview

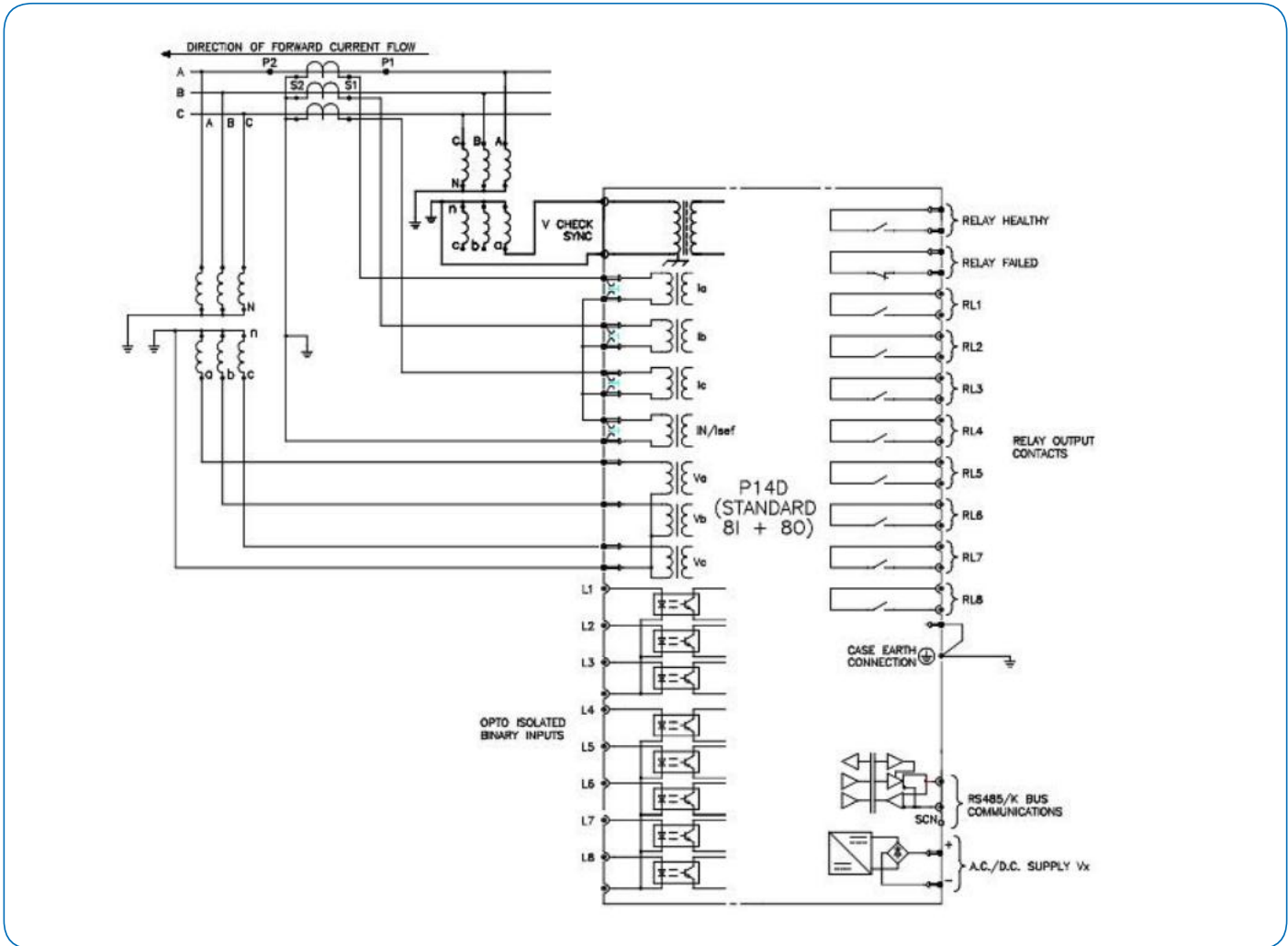

P40 Agile standard hardware (P14D)

Functions	P14NB	P14NZ	P14DB	P14DG	P14DL	P14DZ	P94VB	P94VP	P94VR	P14DH	P14DA
	Non-Directional		Directional				Voltage & Frequency			Directional	
Trip circuit supervision (H7 scheme)	Option										
Rear communications port (software selectable to convert into demodulated IRIG-B)	RS485	RS485	RS485	RS485	RS485	RS485	RS485	RS485	RS485	RS485	RS485
2nd Rear communications port options	RS485, FO, RJ45, dual FO or dual RJ45 Ethernet *										-
Communication protocols	IEC-103, IEC 61850, Modbus, Courier, DNP3, or DNP3 Ethernet										IEC-103, Modbus, Courier or DNP3
Digital inputs min./ max. hardware options	3 / 13	3 / 13	6 / 13	6 / 13	6 / 13	6 / 13	3 / 13	3 / 13	3 / 13	6 / 13	3 / 8
Output relays min./ max. hardware options	4 / 12	4 / 12	8 / 12	8 / 12	8 / 12	8 / 12	4 / 12	4 / 12	4 / 12	8 / 12	4 / 8
CT (AC Current) inputs: 1 and 5A software selectable	3ph + N	3ph + N	3ph + N	3ph + N	3ph + N	3ph + N				3ph + N	3ph + N
100/120V VT (AC voltage inputs)			4	4	4	4	4	4	4	4	4

\* Refer to the Cortec code for possible configurations.

## 30TE and 40TE Models

30TE and 40TE models can accommodate:

- An optional IRIG-B port for time synchronising
- An additional RS485/K-Bus port
- An optional single or redundant Ethernet port for IEC 61850 or DNP3.0
- Optional additional binary I/O: up to 13 binary inputs and 12 binary outputs with options for TCS, depending on the Cortec code
- 40TE model supports 12 binary inputs and 12 binary outputs with TCS and Ethernet communication

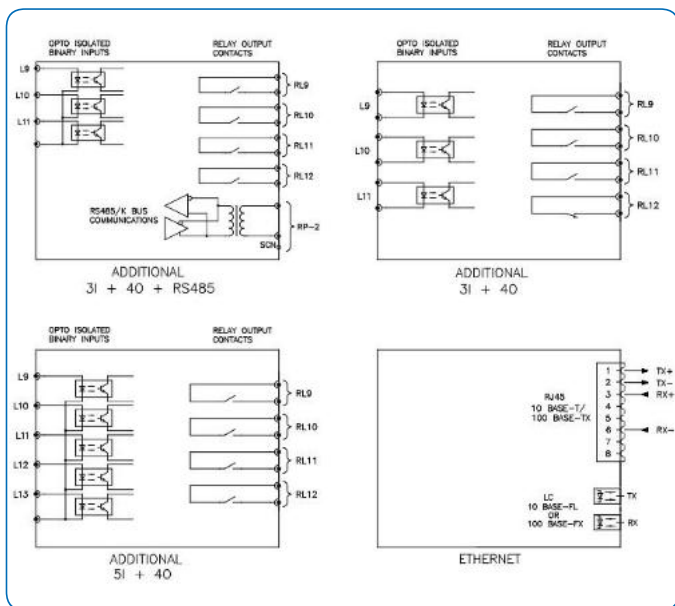

Example hardware options available in case size 30TE

All CT connections have integral shorting, when the IED is withdrawn from the case. This affords additional safety to personnel who may be working near live apparatus.

## Feeder Protection

Ethernet, graphical programmable logic and proven protection, measurement and control algorithms from Grid Solutions' modular MiCOM P40 are native in the new range.

### Phase and Earth Fault Overcurrent

Six independent stages are available for each phase overcurrent element. In addition to definite time and predefined IDMT curve selection, P14N and P14D support user programmable curves for customised operation and resetting.

The profile can be chosen to optimise the protection, without constraining the feeder's loadability. If a standard curve is not suitable for the application, the user can program and upload a custom variant.

There are two standard earth fault elements, each with four independent stages. The first is the EF1 'Measured' element which operates from the quantity flowing directly into the relay's earth (IN) input.

The second standard earth fault element (EF2) operates from a residual current that is derived internally by a mathematical summation of the three phase currents. The sensitive earth fault (SEF) order option fits a sensitive CT, designed for systems whose earth fault current is constrained. A core balance CT should be used to drive this SEF CT input.

Each of the three-phase overcurrent stages of P14D can be independently configured as directional protection and with specific characteristic angle (RCA) and boundaries.

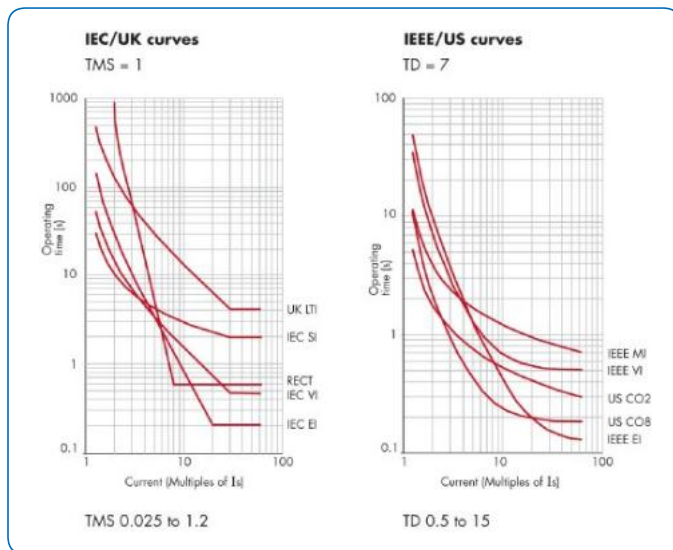

IEC and ANSI/IEEE inverse-time curve profiles

## Special Applications

Load encroachment (blinder), cold load pick-up logic, second harmonic inrush blocking, broken conductor protection, RMS thermal overload protection, wattmetric earth fault, fault locator, auto reclose, switch onto fault, rate of change elements, and check synchronising are built-in depending on the selected model number.

### High Impedance & Transient Earth Fault Detection (HIF & TEFD)

Innovative high impedance earth fault algorithms improve the detection of downed conductors which have fallen on surfaces with high resistivity (eg. sand, dry scrubland, trees). This helps the utility to save human lives, protect nearby animals and lessen the risk of vegetation fires caused by prolonged arcing. Prior to the advent of HIF, such faults may not have been detectable by conventional earth fault methods, due to the extremely low and/or sporadic current flow.

Transient earth fault detection benefits from an advanced and innovative algorithm to detect the direction of single phase faults in compensated power systems.

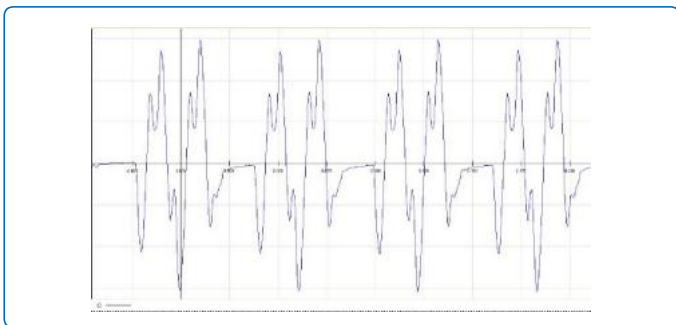

Typical current waveform trace recorded for a downed conductor

### Wattmetric Directional Earth Fault (WDE)

An earth fault in an unearthed 3-phase system causes the phase voltage in the other two phases to increase. This in turn will cause arcing at the fault location. Many distribution systems use a Peterson coil to compensate, thus eliminating the arcing problem. The introduction of a Peterson coil creates difficulties for determining the direction of the fault. Standard directionalising techniques used by conventional feeder protection devices are not adequate. Wattmetric Directional Earthfault (WDE) is used in this scenario to protect compensated networks.

### Distributed Generation Protection

#### Voltage Controlled and Voltage Restrained Overcurrent

Voltage-dependent protection boosts sensitivity and reduces tripping times for faults on weaker systems, such as those with a high prevalence of distributed generation. The timing characteristic can be set as either definite time or IDMT.

#### Power

Two stages of power protection are provided and each stage can be independently configured to operate as over power or under power, forward or reverse directional and active or reactive. Two stages of sensitive power protection are provided. They can be independently selected as reverse power, over power or low forward power.

#### Under / Over voltage

Under/over voltage protection may be configured to operate from either phase-phase or phase-neutral quantities. Three independent stages with definite time elements are available; one of the stages can also be configured with an inverse characteristic.

#### Check Synchronising

The check synchronising feature has predictive close control, to ensure that the CB contacts touch at the instant of synchronism, minimising the stress on plant assets when parallelling.

### Voltage Vector Shift Protection

This function measures the instantaneous change in the three-phase voltage angle that occurs when the connection to the main supply network is lost. To provide stability, this element must be less sensitive than the rate of change of frequency element. However, it operates without any intentional time delay, providing fast tripping.

### Transformer Protection

P14N and P14D devices offer the required current protection with second harmonic blocking, thermal overload protection and instantaneous restricted earth fault element (REF). REF detects transformer winding earth faults, and may be configured as high impedance or low impedance biased differential. Negative sequence overcurrent protection can be set non-directional or directional (forward/reverse) and offers detection of remote phase-phase and phase earth faults.

### Busbar Protection

Phase fault overcurrent element can be applied in a high impedance differential protection scheme for busbars, fitted with external stabilising resistors and non-linear resistors (Metrosils). This solution provides stability for through faults and proper operation for internal faults for single and split busbar arrangements. Alternatively, a peer-to-peer hard-wired or Ethernet scheme can achieve blocked overcurrent unit protection for busbars.

### Load Shedding and Restoration

Nine stages each of frequency protection are available (except P14N). Each may measure in over-, under-, rate of change, frequency supervised rate of change or average rate of change mode.

The wide range of setting options permits application of any frequency based load shedding or islanding scheme. Four stages of rate of change of voltage protection elements are also available, which offer an alternative approach to implement load-shedding schemes.

### Logic and Control Capabilities

All aspects of MiCOM P40, and MiCOM P40 Agile IED configuration are managed using the MiCOM S1 Agile software.

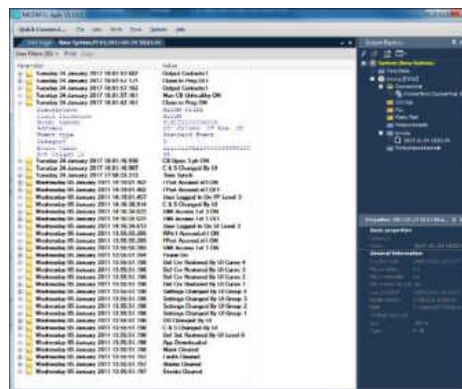

MiCOM S1 Agile: a powerful and intuitive PC-toolsuite

### Circuit Breaker Control

Circuit breaker control is available from the front panel user interface, optically isolated inputs and remotely via the substation communications. Three function keys are available for direct actions instigated by users. The F-keys operate in two modes, normal and toggled, and activate associated signals in PSL that are used to customise the application or operative mode.

### Switch Status and Control

This feature provides status monitoring and control for up to eight switchgear elements. It allows double point status and control over the IEC61850 and DNP3 protocols for various types of switches and disconnectors.

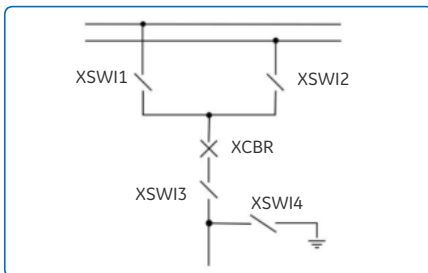

Switch control

### Programmable Scheme Logic (PSL)

Powerful graphical logic allows the user to customise the protection and control functions. It is also used to program the optically isolated inputs, relay outputs and LEDs. The logic includes OR, AND and majority gates, timers, and set/reset latch functions, with the ability to invert the inputs and outputs, and provide feedback. The relay has 32 PSL timers could be conveniently configured in PSL, setting or from the relay front panel. The PSL imposes no delay on logic throughput, using concurrent processing being used instead of sequential equations and avoiding any logic 'race' issues.

### Supervisory and Condition Monitoring Functions

Depending on the hardware base, two stage circuit breaker failure protection, CT / VT supervision, circuit breaker condition monitoring and trip circuit supervision are available. Supervision of the trip circuit in both circuit breaker open and closed

states can be realised using the optically isolated inputs and programmable scheme logic. Full compliance to the benchmark 'H7' supervision scheme is available as a hardware.

### Measurements, Recording, and Post-Fault Analysis

All events, fault and disturbance records are time tagged to a resolution of 1 ms. Up to 2048 time-tagged event records are stored in the flash memory and can be extracted using the communication ports or viewed on the front panel display. Records of the last 10 faults are stored in the flash memory. Fault data is also available via IEC 61850 protocol.

The internal disturbance recorder has up to 9 analogue channels, 64 digital channels and 1 time channel. The memory capacity is approx. 50 records for a typical 0.5 s duration.

The measurements provided, which may be viewed in primary or secondary values, can be accessed via the front panel LCD display, or the communications ports.

Measurements are available in P14D for easy retrofit of KMPC130 devices

### Local and Remote Communications

Two communication ports are standard: a rear port providing remote communications and a front port for substation staff. The front USB port allows the programming of settings, configuration of the programmable scheme logic, extraction and viewing of event, disturbance and fault records, viewing of measurements and the instigation of control functions.

### Feeder Device Track Record

CDG - Forerunner of feeder developments undertaken by Grid Solutions in Stafford, UK since 1949.
MCGG - World's first mass-produced digital relay launched in 1984 and sold over 80,000 units.
KCGG/KCEG - First fully-numerical overcurrent relay launched in 1992 and sold over 100,000 units.
P14x MiCOM series introduced in 1999. Worldwide application, with over 125,000 units delivered.
Addition of UCA2 protocol and Ethernet port in 2004.
Addition of IEC 61850 protocol in 2006.
P40Agile introduced in 2012 and tested in the ILAC-accredited automation product laboratories in Stafford, UK.
61850 and UL certified in 2016.
Worldwide application, with over 32000 units delivered.

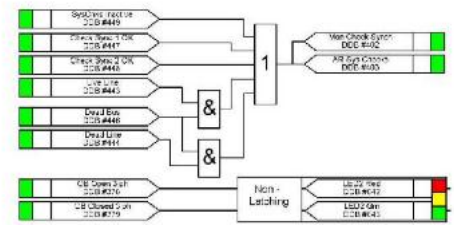

Programmable Scheme Logic

Any of the protocols listed below can be chosen at the time of ordering:

- Courier / K-Bus
- Modbus
- IEC 60870-5-103
- DNP 3.0 (RS485 serial or Ethernet)
- IEC 61850 (100 Mbit/s Ethernet)

IEC 61850 or DNP 3.0 over Ethernet are available when the optional Ethernet port is ordered in 30TE and 40TE models. Redundant Ethernet protocol PRP, HSR and RSTP are also available in dual RJ45 or dual fibre. The copper physical link option uses RJ45 connectors, the fibre option uses LC connectors. IEC 61850 offers high-speed data exchange, peer-to-peer communication, reporting, disturbance record extraction and time synchronisation. To help smooth transition from the existing protocol to the IEC 61850 protocol, the P40 Agile relay had been designed to provide concurrent Courier, Modbus or DNP3 on the RS485 while provide IEC 61850 over Ethernet port.

MiCOM P40 Agile offers 64 virtual inputs, and best-in-class GOOSE performance. An optional second rear Courier port is available, designed typically for local engineering workstation access, or for modem access when the main port is reserved for SCADA.

## Cortec Code / Ordering

	1-4	5	6	7	8	9	10	11	12-13	14	15	Variants
Model Type	P140											Feeder Management Protection IED - Directional
Application		A										Adapted to 20TE case
		B										Base
		G										Small Generator
		L										Load / Line Management
		Z										HIF (SEF CT only)
		H										PWH (Wattmetric Directional Earthfault) (Standard Earth CT only)
Current/Voltage Transformers		1										Standard Earth CT
		2										SEF CT
Hardware Options	20TE/30TE		1									EIA RS485/IRIG-B (demodulated)
	30TE		6									EIA RS485/IRIG-B (demodulated) and Ethernet - Single channel Fibre/Copper (setting configurable as Failover*)
	30TE		8									EIA RS485/IRIG-B (demodulated) and EIA RS485
	30TE/40TE		A									EIA RS485/IRIG-B (demodulated) and Dual Redundant Copper Ethernet - 2x RJ45 Copper (setting configurable as Failover)
	30TE/40TE		B									EIA RS485/IRIG-B (demodulated) and Dual Redundant Fibre Ethernet - 2x multimode fibre (setting configurable as Failover)
	30TE/40TE		C									EIA RS485/IRIG-B (demodulated) and Dual Redundant Copper Ethernet - 2x RJ45 Copper (setting configurable as RSTP)
	30TE/40TE		D									EIA RS485/IRIG-B (demodulated) and Dual Redundant Fibre Ethernet - 2x multimode fibre (setting configurable as RSTP)
	30TE/40TE		E									EIA RS485/IRIG-B (demodulated) & Dual Redundant Copper Ethernet - 2x RJ45 Copper (setting configurable as PRP or HSR)
	30TE/40TE		F									EIA RS485/IRIG-B (demodulated) & Dual Redundant Fibre Ethernet - 2x multimode fibre (setting configurable as PRP or HSR)
	40TE		G									40TE only - EIA RS485, EIA RS485/IRIG-B (demodulated) and Dual Redundant Copper Ethernet - 2x RJ45 Copper (setting configurable as Failover)
	40TE		H									40TE only - EIA RS485, EIA RS485/IRIG-B (demodulated) and Dual Redundant Fibre Ethernet - 2x multimode fibre (setting configurable as Failover)
	40TE		J									40TE only - EIA RS485, EIA RS485/IRIG-B (demodulated) and Dual Redundant Copper Ethernet - 2x RJ45 Copper (setting configurable as RSTP)
	40TE		K									40TE only - EIA RS485, EIA RS485/IRIG-B (demodulated) and Dual Redundant Fibre Ethernet - 2x multimode fibre (setting configurable as RSTP)
	40TE		L									40TE only - EIA RS485, EIA RS485/IRIG-B (demodulated) and Dual Redundant Copper Ethernet - 2x RJ45 Copper (setting configurable as PRP or HSR)
	40TE		M									40TE only - EIA RS485, EIA RS485/IRIG-B (demodulated) and Dual Redundant Fibre Ethernet - 2x multimode fibre (setting configurable as PRP or HSR)
I/O Options	20TE/30TE			A								Standard (8 logic inputs + 8 relay outputs)
	30TE/40TE			B								Total (11 logic inputs + 12 relay outputs)
	30TE/40TE			C								Total (11 logic inputs + 12 relay outputs) suitable for trip circuit supervision
	30TE/40TE			D								Total (13 logic inputs + 12 relay outputs)
	30TE			E								Total (3 logic inputs + 4 relay outputs)
	20TE			F								Total (6 logic inputs + 8 relay outputs) suitable for trip circuit supervision
	40TE			H								Total (10 logic inputs + 12 relay outputs) suitable for trip circuit supervision
	40TE			J								Total (12 logic inputs + 12 relay outputs) suitable for trip circuit supervision
Communication protocol					1							110 - 250 V dc/110 - 230 Vac
					2							Courier
					3							Modbus
					4							IEC60870-5-103 (VDEW)
					6							DNP3.0
					7							IEC 61850 over Ethernet and Courier via rear RS485
					8							IEC 61850 over Ethernet and IEC60870-5-103 via rear RS485
					9							DNP3.0 over Ethernet and Courier via rear RS485
					A							IEC 61850 over Ethernet and Modbus via rear RS485
Case					B							20TE Flush (no function keys, 4 programmable LEDs)
					C							30TE Flush (3 function keys with LEDs, 8 programmable LEDs)
					0							Software only
					3							30TE Flush (Adapted field voltage for KCEG retrofit)
					5							30TE Flush (without field voltage jumpering for KCEG retrofit)
					6							30TE Flush (Additional shorting link)
					D							40TE Flush (3 function keys with LEDs, 8 programmable LEDs)
Language						0						Multilingual (English, French, German, Spanish)
						6						Multilingual (English, Russian, Italian, Portuguese)
						C						Chinese, English or French via HMI, with English or French only via Communications port
Software Reference									**			Unless specified the latest version will be delivered
Customisation / Regionalisation										0		Default
										A		Customer specific
										F		With frequency function (Model P14DB in 20TE Case only)
Hardware design suffix											A	Initial release

Refer to Cortec spreadsheet for possible configurations.

For more information please contact  
GE Energy Connections  
Grid Solutions

### Worldwide Contact Center

Web: [www.GEGridSolutions.com/contact](http://www.GEGridSolutions.com/contact)  
Phone: +44 (0) 1785 250 070

## GEGridSolutions.com

IEC is a registered trademark of Commission Electrotechnique Internationale. IEEE is a registered trademark of the Institute of Electrical Electronics Engineers, Inc. Modbus is a registered trademark of Schneider Automation.

GE and the GE monogram are trademarks of General Electric Company.

GE reserves the right to make changes to specifications of products described at any time without notice and without obligation to notify any person of such changes.

Grid-GA-L3-P40\_Agile-0755-2017\_06-EN. © Copyright 2017, General Electric Company. All rights reserved.



Imagination at work